

# ELICA PRO SERIES LEONE



HEAT GUARD



HUSH SYSTEM



LED REPLACEABLE

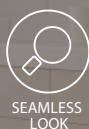

SEAMLESS LOOK



GREASE COLLECTORS



PROFESSIONAL PERFORMANCE

ELICA'S EXCLUSIVE PLUS FEATURES

Give a splash of Italian design to your professional kitchen with Leone's crisp lines, seamless welded corner craftsmanship, beveled rim and gleaming stainless steel.

Leone has the extra depth (24") and power (1200 CFM on 36", 42" & 48" W) & 36" in 600 CFM needed to support professional ranges and cooktops. No ear plugs required with Leone's HUSH sound suppression system, which enables you to comfortably talk and entertain, even when cooking up a storm. Available in 30", 36" and 42" widths, Leone features backlit hidden knob controls which operate the 4-speed blower and LED lighting.

Designed for standard ducted ventilation only.

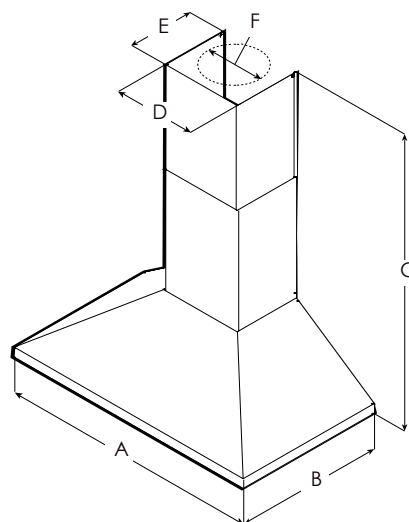

MOUNTING HEIGHT RANGE

	ELN630S2	ELN636SS ELNI 36S2	ELN142S2	ELN148SS
A	30" (76.2 cm)	36" (91.4 cm)	42" (106.7 cm)	48" (121.9 cm)
B	24" (61 cm)			
C	Max: 47 5/8" (120.9 cm) Min: 30" (76.2 cm)			
D	13 1/8" (33.2 cm)			
E	10 5/8" (27 cm)			
F	8" (20.3 cm)			







# ELICA PRO SERIES LEONE



## SPECIFICATIONS

Width:	30" Unit	36" Unit	42" Unit	48" Unit
Model:	ELN630S2	ELN636SS (600 CFM)* ELN136S2 (1200 CFM)**	ELN142S2	ELN148SS
Dimensions:	30"W x 24"D x 12 1/8"H	36"W x 24"D x 12 1/8"H	42"W x 24"D x 12 1/8 "H	48"W x 24"D x 12 1/8 "H
Blower Type(internal):**	600 CFM(4-speed)	600 CFM (4-speed)* 1200 CFM (4-speed)**	1200 CFM(4-speed)	1200 CFM(4-speed)
Noise (sones):**	7 Sones	7 Sones* 8.5 Sones**	8.5 Sones	
Finish:	Stainless Steel			
Controls:	Fully Retractable Rotating Knobs with Blue Backlight			
Illumination:	2 LED, 6.5 W, 3000 K, 540 Lumen/Lamp			
Grease Filter:	Dishwasher-Safe, Professional Stainless Steel Baffle 2 for 30", 36", 42" & 3 for 48"			
Duct Transition:	8" Round with BackDraft Damper (top only)			
Installation Type:	Ducted Installation Only			
Telescopic Chimney:	For ceiling heights 7'6" - 10'0" (over electric cooking), 8'0" - 10'0" (over gas cooking)			
Electrical:	120V - 60 Hz, 463 W	120V - 60 Hz, 490 W * 120V - 60 Hz, 913 W **	120V - 60 Hz, 913 W	120V - 60 Hz, 913 W
KITS:	Long Chimney Ext.: KIT02785 (Can reach up to 13") 1200 CFM External Blower: KIT0153054 1200 CFM In Line Blower: KIT0154387 Inline Blower Shell Kit: KIT0179549(for use with 1200 CFM blowers only) External Blower Shell Kit: KIT0179547(for use with 1200 CFM blowers only) Electronic CFM Reduction Bypass KIT: KIT0185752 (for 600 CFM Blower), KIT0185099 (for 1200 CFM Blower)			
WARRANTY:***	Two (2) Years Parts & In-Home Labor. Earn an additional One (1) Year of Parts & In-Home Labor by registering on elica.com.			

## PLUS FEATURES

- 
**HUSH SYSTEM** - An exclusive sound deadening technology that effectively reduces sound levels by over 35%
- 
**LED CONSUMER REPLACEABLE BULB** - High quality LED lighting usually requires a skilled technician to replace lamps. Avoid this expense with Elica's new LED lamps that enable homeowners to replace in seconds
- 
**SEAMLESS CRAFTSMANSHIP** - Heavy gauge stainless steel "Seamless" construction that delivers refined elegance.
- 
**STAINLESS STEEL BAFFLE FILTERS WITH GREASE COLLECTORS** - Designed for high airflow cooking, the "S" shape design traps high volumes of grease
- 
**PROFESSIONAL PERFORMANCE** - Special features and high performances for models with aspiration capacity between 600 and 1200 CFM's
- 
**HEAT GUARD** - Senses extreme temperatures (>316 °F) and automatically adjusts the blower speed to HIGH



Model	HVI Certified Ratings	High Speed	Working Speed	Duct Size
ELN630S2 ELN636Ss	CFM Sones	460 9.5	160 0.8	8" Vertical
ELN136S2 ELN142S2 ELN148SS	CFM Sones	780 12.5	310 3	8" Vertical

\* The product images shown are for illustration purposes only and may not be an exact representation of the product.

\*\* Blower performance indicates the performance of the blower by itself. Performance claims are not HVI certified but were established in accordance with HVI Standardized test procedure. For Certified Ratings, please refer to HVI Certified Product Directory.

Electric Ratings are declared according to UL.

\*\*\* For valid warranty extension, register within 3 months from purchase. For USA & Canada Users Only.