

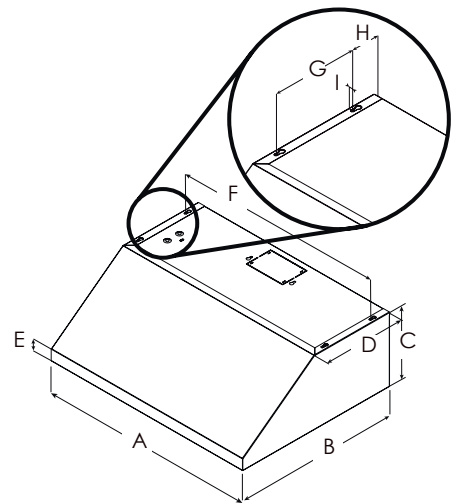

- HEAT GUARD
- HUSH SYSTEM
- LED REPLACEABLE
- SEAMLESS LOOK
- GREASE COLLECTORS
- PROFESSIONAL PERFORMANCE

ELICA'S EXCLUSIVE PLUS FEATURES

Available in 30" and 36" widths and only 11 1/32" high, the Cervinia is a streamlined version of the full-size Calabria model. This hood features professional styling, seamless welded corner craftsmanship, a powerful 600 CFM blower with high airflow, heavy duty stainless steel baffle grease filters, Replaceable LED lighting, plus backlit hidden metallic in/out knobs for convenience and safety. Cervinia also delivers higher efficiency and easy maintenance for a cleaner kitchen.









	ECV630S3	ECV636S3
A	30" (76 cm)	36" (91.54 cm)
B	23" (58.4 cm)	
C	11 1/32" (27.9 cm)	
D	11 11/16" (29.7 cm)	
E	2 9/32" (6.6 cm)	
F	29" (73.3 cm)	35" (88.9 cm)
G	7 1/2" (19 cm)	
H	2 9/16" (6.5 cm)	
I	3/8" (1 cm)	

ELICA PRO SERIES CERVINIA

SPECIFICATIONS

Width:	30" Unit	36" Unit
Model:	ECV630S3	ECV636S3
Dimensions:	30"W x 23"D x 11 1/32 "H	36"W x 23"D x 11 1/32 "H
Blower Type(internal):**	600 CFM (4 -speed)	
Noise (sones):**	7 Sones	
Finish:	Stainless Steel	
Controls:	Fully retractable rotating knobs with blue backlighting	
Illumination:	2 LED, 6.5 W, 3000 K, 540 Lumen/Lamp	
Grease Filter:	(2) Dishwasher-Safe, Professional Stainless Steel Baffle filter	
Duct Transition:	3 1/4" x 10" Rectangular transition (Top or Rear)	
Installation Type:	Ducted Installation Only	
Electrical:	120V - 60 Hz, 457 W	
KITS:		
Long Chimney Extension Kit 6":	KIT02159	KIT02158
Long Chimney Extension Kit 12":	KIT02160	KIT02161
Back Splash Kit:	KIT0142864	KIT0142867
Inline Blower Kit:	KIT0154387 (for use with 1200 CFM blowers only)	
External Blower Kit:	KIT0153054 (for use with 1200 CFM blowers only)	
CFM Reduction Bypass Kit:	KIT0185097	
WARRANTY:***	Two (2) Years Parts & In-Home Labor. Earn an additional One (1) Year of Parts & In-Home Labor by registering on elica.com.	

PLUS FEATURES

-  **HUSH SYSTEM** - An exclusive sound deadening technology that effectively reduces sound levels by over 35%
-  **LED CONSUMER REPLACEABLE BULB** - High quality LED lighting usually requires a skilled technician to replace lamps. Avoid this expense with Elica's new LED lamps that enable homeowners to replace in seconds
-  **SEAMLESS CRAFTSMANSHIP** - Heavy gauge stainless steel "Seamless" construction that delivers refined elegance.
-  **STAINLESS STEEL BAFFLE FILTERS WITH GREASE COLLECTORS** - Designed for high airflow cooking, the "S" shape design traps high volumes of grease
-  **PROFESSIONAL PERFORMANCE** - Special features and high performances for models with aspiration capacity between 600 and 1200 CFM's
-  **HEAT GUARD** - Senses extreme temperatures (>158 °F) and automatically adjusts the blower speed to HIGH



Certified Ratings	High Speed	Working Speed	Duct Size
CFM Sones	430 11	160 2	3.25 x 10" (Horizontal)
CFM Sones	442 11	177 2	3.25 x 10" (Vertical)

* The product images shown are for illustration purposes only and may not be an exact representation of the product.

** Blower performance indicates the performance of the blower by itself. Performance claims are not AHAM certified but were established in accordance with HVI Standardized test procedure. For Certified Ratings, please refer to AHAM Certified Product Directory. Electric Ratings are declared according to UL.

*** For valid warranty extension, register within 3 months from purchase. For USA & Canada Users Only.